

# Smart Helmet For Mining Workers

**Prof. Poornima<sup>1</sup>, Adiba Begum<sup>2</sup>, Akshata<sup>3</sup>, Poornima<sup>4</sup>, Malika<sup>5</sup>**

*<sup>1</sup>Assistant Professor, Department Electrical And Electronics Engineering, Godutai Engineering College Exclusive For Women's Sharanbasva University Kalaburgi, India.*

*<sup>2,3,4,5</sup>Students, Department Electrical And Electronics Engineering, Godutai Engineering College Exclusive For Women's Sharanbasva University Kalaburgi, India.*

---

## ABSTRACT

---

The proposed project aims to develop a smart helmet for mining workers, which integrates multiple sensors, communication modules, and emergency features to enhance the safety of workers in hazardous working environments. The smart helmet incorporates a gas sensor MQ2 to detect hazardous gases, DHT11 temperature and humidity sensor to monitor environmental conditions, an emergency switch to trigger an alert in case of an emergency, a 16\*2 LCD to display real-time data, and a buzzer to sound an alarm in case of a critical situation. Additionally, the smart helmet integrates a GSM modem to send emergency SMS messages to predefined numbers, GPS location tracking, and an ESP8266 WiFi module for IoT communication. The Blynk app is used for data visualization, which allows users to remotely monitor the real-time data from the helmet. Thus, the smart helmet provides an advanced safety system for mining workers, which improves situational awareness, reduces accident risks, and enables rapid response in case of an emergency.

---

**Keywords:** Smart Helmet, Iot, Coal Mines Safety Monitoring, Mobile Application.

---

## I. INTRODUCTION

Mining is essential to the economy of every country since it opens up countless opportunities across many industries. We are fortunate to recognize the benefits that this business generates by processing the materials it offers as a community. When working outside, there are various specific risks to one's health and safety. Unpleasant or unstable conditions exist. As the mines get more profound, the risk of doing chores could go up. It poses problems. As a result, we recommend a mining security system that also includes a mining monitoring system based on microcontroller-based circuits. We use gadgets to keep tabs on workers traveling about the mining site. A monitoring system integrated within the helmet uses Wi-Fi to connect to each tracker and relay data. Mega microcontroller-based Wi-Fi tracker circuitry is used in the technique to gather the data. Employee locations could be mapped as a result.

A button that is hooked into the circuit of each employee's helmet is also included. There is an emergency, as indicated by this button. Almost any situation could be handled using this, even breathing poisonous gas, cave-ins, physical harm, etc. IoT thereby ensures the security of mining employees. With an estimated 184.623 billion tonnes of reserves, Pakistan possesses sizable coal deposits, mainly in Sindh. Our nation's market has been proliferating, which has led to an increase in the number of raw materials. New foreign businesses aid the search for coal reserves. The safety of miners cannot be ensured, coal manipulation cannot be done, and terrible incidents in mines are on the rise due to a lack of qualified employees. Environmental factors must be overcome by those who operate in coal mining.

## II. LITERATURE SURVEY

Yongping Wu and Guo Feng proposed Bluetooth wireless transmission technology for a coal mine monitoring system. Low-power, low-cost wireless bridging systems used for unified, global short-range communication will become standardized thanks to Bluetooth technology. Utilizing well-known CAN bus technology, the system integrates wired and wireless data transfer techniques successfully [1].

Bluetooth is a short-range wireless technology, making it challenging to use cables, which presents the system's main challenge. Jingliang Song and Yingli Zhu implemented an automatic coal mine safety monitoring system with a wireless sensor network. The microcontroller sends the sensor groups' measurements of the system's temperature,

humidity, and other factors in the deep mine to the wireless communication module. [2]

The data is transmitted across a cable to a remote monitoring site. Pranjali Hzarika urged mandating the use of safety helmets for coal mine workers. This helmet comes with carbon monoxide and methane gas sensors. This sensor can detect gas using a wireless Zigbee module attached to the helmet, and the information is remotely transmitted to the control center.[3]

Mustafa Abro et al. [3] and Abid et al. They unveiled a wearable IoT-based jacket. It is designed to protect those who work in coal mines and are frequently exposed to risks. This prototype is constructed to sense various things, including hazardous chemicals, a coal miner's heartbeat, the circumstances beneath, and the miner's location via GPS. These details will likely be sent to a dynamic internet protocol through a Wi-Fi encrypted channel. [4]

D. Kock et al.'s development of automation benefited coal miners tremendously. It was developed in South Africa for the miners. Cooperative research was done on coal port detection (CID). They did this by employing two commonly used methods, analysis and gamma radiation vibration naturally occurring in the environment. [5]

Gaidhane et al. have suggested a safety system for mine employees based on Zig Bee technology. Additionally, it monitors gas levels, which is dangerous because the accumulation of hazardous gases in the mines is the primary cause of mine-related fatalities. Several LEDs are turned on when the value reaches the threshold, and a ZigBee warning is sent out. [6]

Cheng Qiang et al. proposed a wireless IoT-based communication system for coal miners that monitors temperature, humidity, and CH<sub>4</sub> (methane) levels. Through voice communication, the miner is alerted about the situation by the man tracking in the floor channel.[7]

### III. EXISTING SYSTEM

The main drawback of this approach is that using wires is challenging due to Bluetooth's short-range wireless capabilities. The microcontroller sends information from the sensor groups for the system's temperature, humidity, and other parameters to the wireless communication module. The cable sends the data collection to a nearby monitoring station. If a worker is wearing a helmet when they fall, this system cannot tell.

### IV. PROPOSED SYSTEM

The Smart Helmet Offers Real-Time Monitoring Of Hazardous Gases, The Right Light Level For The Job, Humidity, Whether The Miner Is Wearing A Helmet, And The Worker's Position. IOT-Based Wireless Networks Provide The Most Efficient Means Of Communication Between Base Stations And Underground Mines. If Any Of The Sensor Data Exceeds The Rated Or Threshold Values, The Buzzer Alerting Device Is Utilised To Notify The Supervisor Or The Person At The Base Station.

The proposed study consists of an IoT-based smart helmet, which helps underground workers in many ways. It tells the predetermined services of coal miners, such as the gas sensor, temperatures, humidity, and many other things that are essential for the safety of the miners. This helmet is made up of a helmet with detectors. The transmitter segment has a microcontroller which receives input from several sections such as a helmet remover sensor, collision sensor, and gas sensor. At a particular instance, when a harmful event happens, the helmet transfer alert towards the application is fixed on several different areas of the coal mine. The helmet remover, gas sensors, and collision sensors will feel the corresponding parameters.

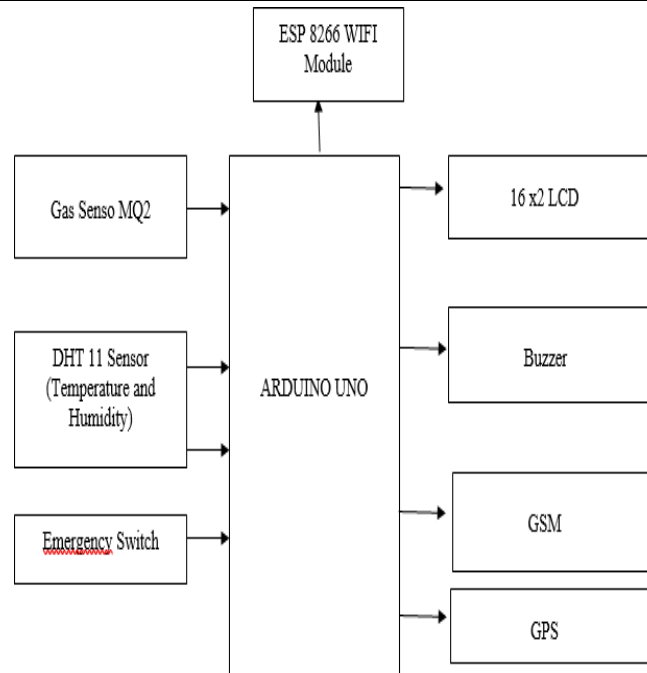

Fig.1. Proposed System.

The software design stage is created in accordance with the study's operating flow. Sequence programming and interface programming are the two categories in which the software is split. In order to achieve the project's approved goal, both sections must be connected and run at the same time.

The steps of testing, adjusting, and troubleshooting are crucial in the design process. These steps occur after the hardware and software components have been combined. As a result, even a minor design flaw might be time-consuming, requiring retracing back to earlier stages for confirmation.

## V. HARDWARE AND DESCRIPTION

### A. ARDUINO UNO

Arduino is an open-source platform used for building electronics projects. Arduino consists of a physical programmable circuit board (often called a microcontroller) and a piece of software, or IDE (Integrated Development Environment), that runs on your computer used to write and upload computer code to the physical board.

The Arduino platform has become quite popular with people just starting with electronics, and for a good reason. Unlike most previous programmable circuit boards, the Arduino does not need a separate piece of hardware (a programmer) to load new code onto the board – you can use a USB cable.

Additionally, the Arduino IDE uses a simplified version of C++, making it easier to learn to program. Finally, Arduino provides a standard form factor that breaks out the microcontroller's functions into a more accessible package.

The Arduino is a microcontroller board based on the ATmega8. It has 14 digital -input/output pins (of which six can be used as PWM outputs), six analog inputs, a 16 MHz ceramic resonator, a USB connection, a power jack, an ICSP header, and a reset button.

It contains everything needed to support the microcontroller; connect it to a computer with a USB cable or power it with an AC-to- DC adapter or battery to get started.

The Uno differs from all preceding boards because it does not use the FTDI USB-to-serial driver chip. Instead, it features the Atmega16U2 (Atmega8U2 up to version R2) programmed as a USB-to-serial converter. Revision 2 of the Uno board has a resistor pulling the 8U2HWB line to the ground, making it easier to put into

DFU mode.



Fig.2. Arduino Uno board

### B. MQ2 SENSOR

MQ2 gas sensor is an electronic sensor used for sensing the concentration of gases in the air such as LPG, propane, methane, hydrogen, alcohol, smoke and carbon monoxide.

MQ2 gas sensor is also known as chemiresistor. It contains a sensing material whose resistance changes when it comes in contact with the gas. This change in the value of resistance is used for the detection of gas.



Fig.3. MQ2 Sensor

### C. TEMPERATURE AND HUMIDITY SENSOR

The DHT11 is an essential, ultra low-cost digital temperature and humidity sensor. It uses a capacitive humidity sensor and a thermistor to measure the surrounding air. It spits out a digital signal on the data pin. It's relatively simple to use but requires careful timing to grab data. The only real downside of this sensor is you can only get new data from it once every 2 seconds. So sensor readings can be up to 2 seconds old when using the library.

The two primary varieties of RFID readers are handheld and fixed. Whereas chosen readers are normally installed in a certain location, such as a warehouse or a production line, handheld readers are portable and may be carried about. Several frequencies, such as low frequency (LF), high frequency (HF), ultra-high frequency (UHF), and microwave frequencies, are used by RFID readers and RFID tags to interact. The application and the distance between the reader and the tag determine the type of frequency that is employed.

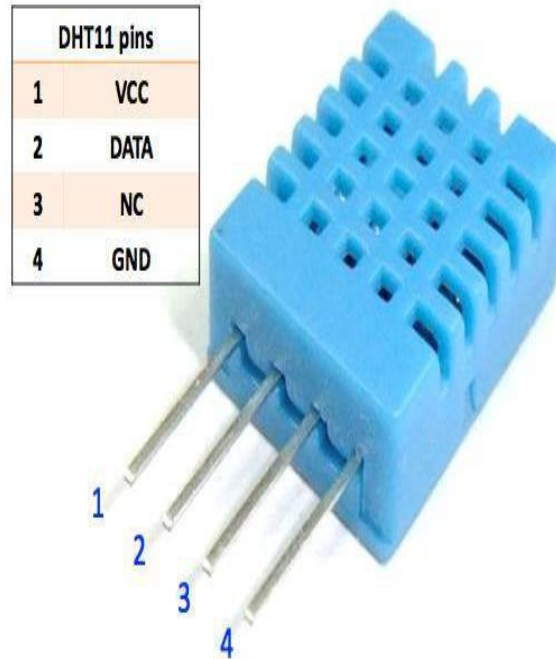

Fig.4. DHT-11 Sensor.

#### D. 16x2 LCD DISPLAY

We come across Liquid Crystal Display (**LCD**) displays everywhere around us. Computers, calculators, television sets, mobile phones, and digital watches use some kind of display to display the time.

An LCD screen is an electronic display module that uses liquid crystal to produce a visible image. The 16x2 LCD display is a very basic module commonly used in **DIYs** and circuits. The 16x2 translates a display of 16 characters per line in 2 such lines. In this LCD, each character is displayed in a 5x7 pixel matrix.

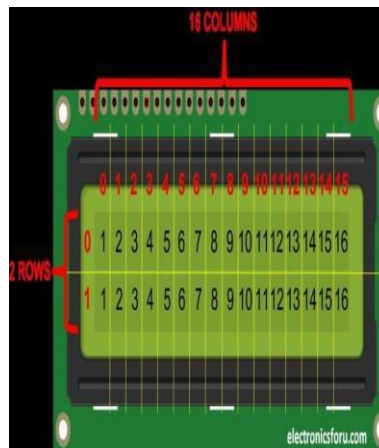

Fig.5.16\*2 LCD Display.

Once the display is properly connected and configured, you can send text and other information to the display using a variety of commands, such as "clear display", "move cursor", and "write character". The display can also be configured to show custom characters or graphics, allowing for more advanced visualizations.

### E. GSM MODEM

A GSM modem is a specialized modem that accepts a SIM card and operates over a subscription to a mobile operator, just like a mobile phone. From the mobile operator's perspective, a GSM modem looks just like a mobile phone. When a GSM modem is connected to a computer, this allows the computer to use the GSM modem to communicate over the mobile network. While these GSM modems are most frequently used to provide mobile internet connectivity, many can also be used to send and receive SMS and MMS messages. GSM modem must support an “extended AT command set” for sending/receiving SMS messages. GSM modems can be a quick and efficient way to get started with SMS, because a special subscription to an SMS service provider is not required. In most parts of the world, GSM modems are a cost-effective solution for receiving SMS messages because the sender pays for the delivery. To begin, insert a GSM SIM card into the modem and connect it to an available USB port on your computer.



Fig.6. GSM Modem

### F. BUZZER

A buzzer often emits a loud, constant, and frequently unpleasant sound. It is commonly employed as an alarm or warning signal in industrial settings or during emergencies. Generally speaking, "buzzer" and "beeper" are frequently used interchangeably, and their precise meanings can differ depending on the situation.



Fig.7. Buzzer



#### H. NEO 6M GPS MODULE

For serial communication, it uses a UART interface. It is simple to integrate with a variety of microcontrollers. It requires a DC input between 3.3 and 5 volts because it has a built-in voltage regulator. It is equipped with a "patch antenna" style of antenna. It performs well at a baud rate of 9600 and requires ample space since it needs a clear line of sight to the satellites.



Fig.8. UBLOX NEO-6M-GPS-Module.

#### I. EMERGENCY SWITCH

An emergency stop switch is a safety device used to turn off the equipment in a crisis when it cannot be turned off usually. When there is a risk of injury or the need to stop the operation, an emergency push button is meant to stop the machinery swiftly.

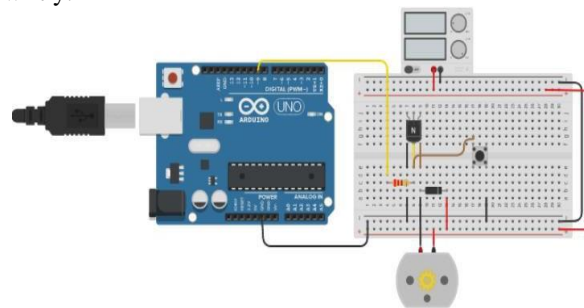

Fig.9. Emergency Switch

#### H. ESP 8266 WIFI MODULE

The ESP8266 wifi module is low cost standalone wireless transceiver that can be used for end-point IoT developments. ESP8266 wifi module enables internet connectivity to embedded applications. It uses TCP/UDP communication protocol to connect with the server/client.

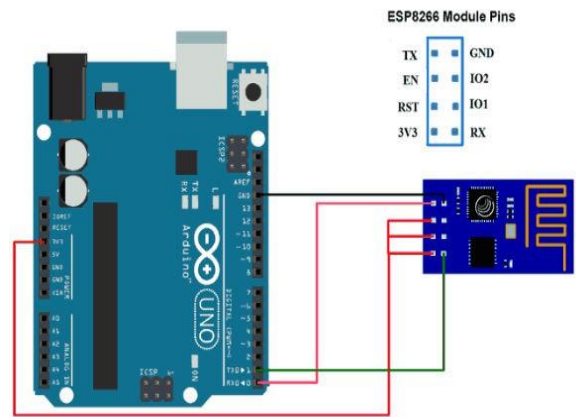

Fig.10. Emergency switch.

## VI. SOFTWARE AND DESCRIPTION

### A.ARDUINO IDE

The Arduino Integrated Development Environment or Arduino Software contains a text editor for writing code, a message area, a text console, a toolbar with buttons for common functions and a series of menus.



Fig.11. Arduino IDE. B.BLINK APP

Blynk is an Internet of Things Platform aimed to simplify building mobile and web applications for the Internet of Things





Fig.12. Device Setup.

## VII. RESULTS

This section discusses the results of the proposed system. The sensors sense the environmental conditions around the miner working in underground mining. All the real time data is display on LED, and also updated on the web by using IoT with the help of Thing speak. If any of the environmental parameters exceeds its standard value the miner, co-miners, supervisor and the control station get notify by buzzer. If any hazardous event occurred in the mine in such case the control station will be able to provide the rescue team as early as possible.

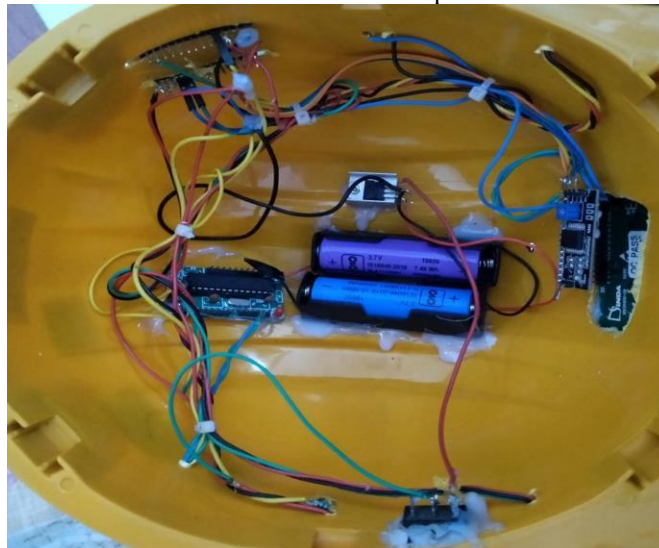

Fig.13 Outlook of smart helmet.

This system connects the Arduino to the computer. To build this system, open-source solutions were provided, and components used in the proposed safety alert system, such as the MQ-2, Gas Sensor, ESP32, DHT11 and others, can be easily connected with the Arduino platform.



Fig.14. Temperature and humidity values and helmet setup.

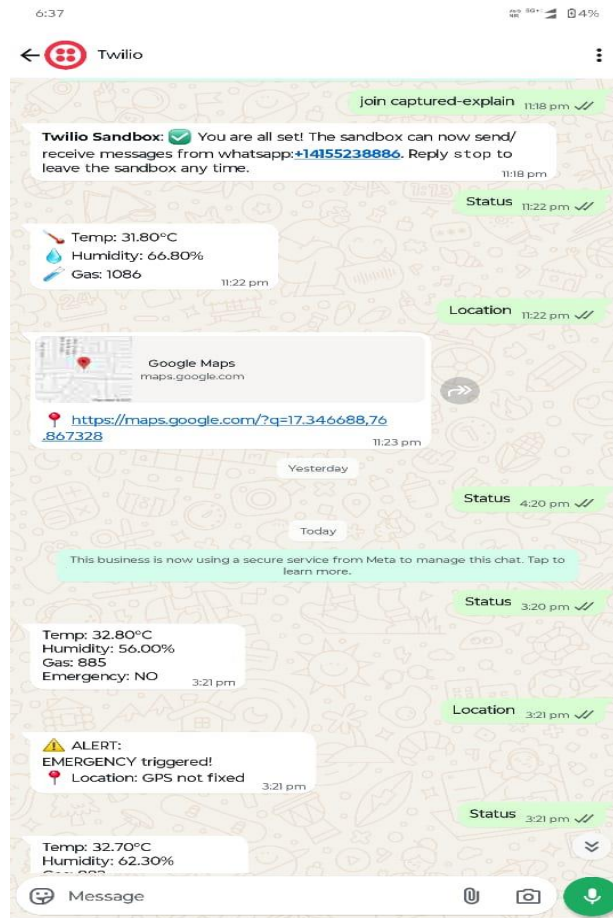

Fig.15. Blynk App notification.

## VII. CONCLUSION & FUTURE SCOPE

In conclusion, the smart helmet for mining workers is a cutting-edge technology that incorporates several sensors and communication modules to provide safety to workers in hazardous environments. The helmet includes a gas sensor (MQ2) to detect harmful gases, a DHT11 temperature and humidity sensor to monitor the environment, an emergency switch, a 16\*2 LCD, a buzzer, a GSM modem for sending SMS emergencies, GPS location tracking, an ESP 8266 wifi module for IoT communication, and a Blynk app for data visualization. The gas sensor MQ2 detects hazardous gases, and the DHT11 temperature and humidity sensor keeps track of the environment's temperature and humidity. The emergency switch enables the worker to request help in case of any emergency. The 16\*2 LCD displays the information collected by the sensors, and the buzzer alerts the worker in case of any danger. The GSM modem sends SMS emergencies to the designated contacts, and GPS location tracking ensures that workers can be located in case of an emergency. The ESP 8266 wifi module provides IoT communication, and the Blynk app helps visualize the data collected by the sensors. In future work, smart helmet-based personal PWS can be expanded by adding sensors to the Arduino board. For example, a heart rate or alcohol sensor can be added to check the worker's condition. Furthermore, by adding a temperature, humidity, methane gas, and carbon monoxide sensor, the environment at the mine site can be monitored. When a high concentration of harmful gases is detected, the pedestrian worker can be warned of danger. The worker could then follow appropriate protocols to ensure safety.

---

**REFERENCES**

- [1] Liu Xiaoli, GuoLiwen and Zhang Zhiye, "Statistics Analysis of death Accident in Coal Mines from January 2005 to 2009", IEEE 2010.
- [2] Zhou, Xin-quan, and Chen Guo-xin, "The probability analysis of occurrence causes of extraordinarily serious gas explosion accidents and its revelation". Journal of China Coal Society, 2008, 33 (1): 42-46.
- [3] GAO junyao, GAO xueshan, ZHU wei, ZHUjianguo, WEI boyu. "Coal Mine Detect and Rescue Robot Design and Research" IEEE 2008.[4] Jong C. Wang, Yan Ting Lin, Hwei Teng Jheng, Jyun Sian Wu and Ruei Jhe Li, "Object Tracking for Autonomous Biped Robot" IEEE 2010
- [5] GAO junyao, GAO xueshan, ZHU jianguo, ZHU wei, WEI boyu, WANG shilin "Coal Mine Detect and Rescue Robot Technique Research", IEEE Proceeding, International Conference on Information and Automation, June 2009.
- [6]M. Thamrin N., Rosman R, and Sarmawi D. S, "Design and Analysis of Wireless Controller Panel using RF Module's for Robotic Wheelchair" IEEE 2011.
- [7] Heng Huang, Fillia Makedona, Dan Popab, and Harry Stephanoub, "A feature extraction method for multimedia data analysis in robot wireless sensor networks". IEEE 2007
- [8] Shan Cai, Zhao-long, Xu Jie Yang, and Xiao-zhi Liu "Detecting Robot System for Mine Disasters". ICEEE 2010
- [9] Ward.C, Iagnemma.C.K, "A Dynamic Mobile Based Wheel Slip Detector for Mobile Robots on Outdoor Terrain", Robotics, IEEE Transactions on Volume 24, Issue 4, Page(s):821-831, Aug 2008.
- [10] Derek Engelhaupt Experiment with the Intelligent Robotics Institute of Beijing "R/C Combat Vehicles Track Systems", 2009.
- [11] Gandikota, Jones and Fleischer, "Determining the range of heat transfer coefficients from the carbon fibers using FC-72" Experiment with the Pennsylvania Infrastructure Technology Alliance.
- Ishay Knmon, Elon Rimon, Ehud Rivilin, "Tangent bug: A Range-Sensor-Based Navigation Algorithm", The International Journal of Robotics Research, Vol.17 No 9, Pages: 934-953, September 1998.
- [12] Vladimir.J, Lumelsky, Alexander.A, "Path Palanning strategies for a point mobile automation moving amidst unknown obstacles of arbitrary shape", Algorithmica, 2(1):403-430, March 1987

